

ShowerPerfect™ SM Installation Kit

Shower installation kit designed for waterproofing *Mapelastic™ WSM* sheet membrane
sheet membrane



INSTALLATION GUIDE IGT0414

As tile formats continue to grow, the trend is to carry this continuous-plane look into the shower compartment (see Figure 1). MAPEI's *ShowerPerfect* SM Installation Kit provides a pre-sloped linear drain system designed to be used with MAPEI's *Mapelastic WSM* waterproofing sheet membrane for tile, stone or glass tile shower installations.

The *ShowerPerfect* linear drain system is designed to be installed in standard showers from 26" x 32" to 36" x 61" (66 x 81 cm to 91 x 155 cm) interior dimensions. (For additional industry information, refer to Note 1 in the "Applicable Industry Codes, Standards and Guidelines" section below.) The drain and slope can be oriented anywhere within the shower receptor, and the drain can be extended for an interior dimension width of up to 32" (81 cm) (see Figure 2).



Figure 1: *ShowerPerfect* linear drain

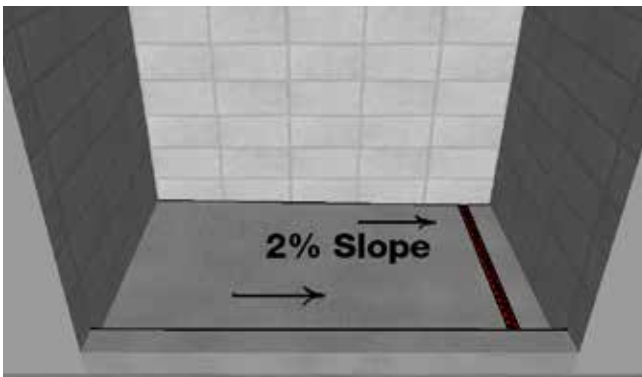

Figure 2: *ShowerPerfect* pre-sloped pan, 2% slope to drain

FEATURES AND BENEFITS

- Factory-supplied, single-plane, pre-sloped pan to drain; eliminates the need for the field-adjusted slope to drain
- Designed to accommodate large-format ceramic (standard or thin-body), glass or stone tile
- Multiple shower strainer designs, including field-matched tile-in strainer
- Patented drain assembly made of durable PVC
- *Mapelastic WSM* waterproofing sheet membrane is sandwiched between the PVC body, *ShowerPerfect* Hybrid Sealant and the stainless-steel frame.
- *ShowerPerfect* Pre-Sloped Panel, *ShowerPerfect* Drain Support Frame and *ShowerPerfect* Curb contain 28% post-consumer content and are made of 100%-recyclable, patent-pending structural foam. See the chart below regarding potential LEED points associated with these products:

LEED Points Contribution

MR Credit 4, Recycled Content* Up to 2 points

LEED Points

* Using this product may help contribute to LEED certification of projects in the category shown above. Points are awarded based on contributions of all project materials.

- Simple installation steps:
 1. Pan and drain support frame are bonded to the subfloor using a fast-setting, polymer-modified, thin-set mortar.
 2. Attach the waste pipe by either gluing the drain waste outlet to the 2" (5 cm) PVC drain waste line using a hub-to-hub coupling or attaching the no-hub coupling to the 2" (5 cm) PVC drain waste line and waste outlet.
 3. Drain extenders allow the linear drain to be custom-fit from wall to wall, up to 32" (81 cm).
- *Mapelastic WSM* installs easily on all panels and walls using *Ultraflex™ RS* mortar and *ShowerPerfect* Hybrid Sealant for all seams and corners, ensuring a continuous waterproofing membrane layering system.
- *ShowerPerfect* SM linear drain system conforms to the following listings and approvals:
 - Plumbing, Mechanical, Fuel Gas and Swimming Pools/Spas (PMG) products certified by International Code Council (ICC-ES)
 - ECC Evaluation Service Report PMG 1243
 - Canada's cUPC (Uniform Plumbing Code) products listed by the International Association of Plumbing and Mechanical Officials (IAPMO)
 - IAPMO File #K-8827

WHERE TO USE

- Standard showers with interior dimensions from 26" x 32" to 36" x 61" (66 x 81 cm to 91 x 155 cm)
- Tub-to-shower conversions
- Commercial (e.g., hotels, hospitality facilities, institutions and dormitories)
- Light commercial and residential (e.g., office buildings, condominium residences and single-family homes)

ACCEPTABLE SUBSTRATES

- Concrete slabs
- Cementitious mortar beds
- Cement backer units (CBUs)
- Exterior-grade plywood

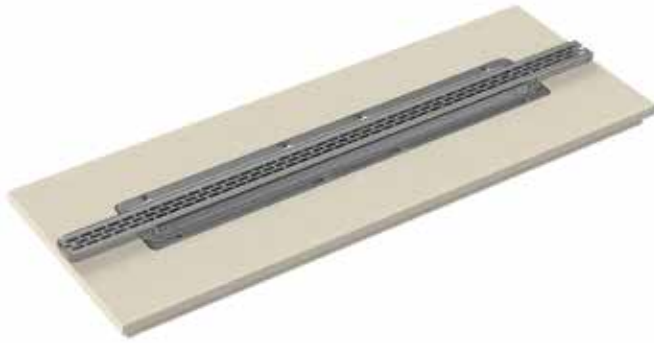

Figure 3: Drain assembly – assembled view

INSTALLATION OF DRAIN SYSTEM

1. The substrate must be structurally sound and capable of supporting the entire tile assembly. The substrate is to be fully cured and free of soap scum, dust, dirt, oil, wax, sealers, paint, coatings, and any other substances that could reduce or inhibit proper adhesion and system performance. Make sure that the subfloor is close to level. If thin-set thickness will exceed 3/16" (4,5 mm) anywhere under the pan, the substrate should be leveled first and then thin-set should be used to set the pan (see Step 6).
2. The shower installation should meet all state, federal, local, provincial and applicable building code requirements. (Refer to the "Applicable Industry Codes, Standards and Guidelines" section below.)
3. Install backer board on the walls and secure to the studs per the manufacturer's instructions. The backer board will sit behind the drain support frame and pan. Tape all joints and prep the backer board for waterproofing, in accordance with the backer board manufacturer's instructions.
4. Recommended location, size and length of the Linear Drain Body in relation to the 2" (5 cm) waste pipe line (or "stub-out") (see Figure 4):
 - Place the hub-to-hub coupling on top of the ID PVC waste pipe line.
 - Establish the Linear Drain Body position 3" to 6" (7,5 to 15 cm) away from the closest parallel wall and center it along the length of the wall.
 - Mark off the drain pipe line to a length just below the top of the subfloor.

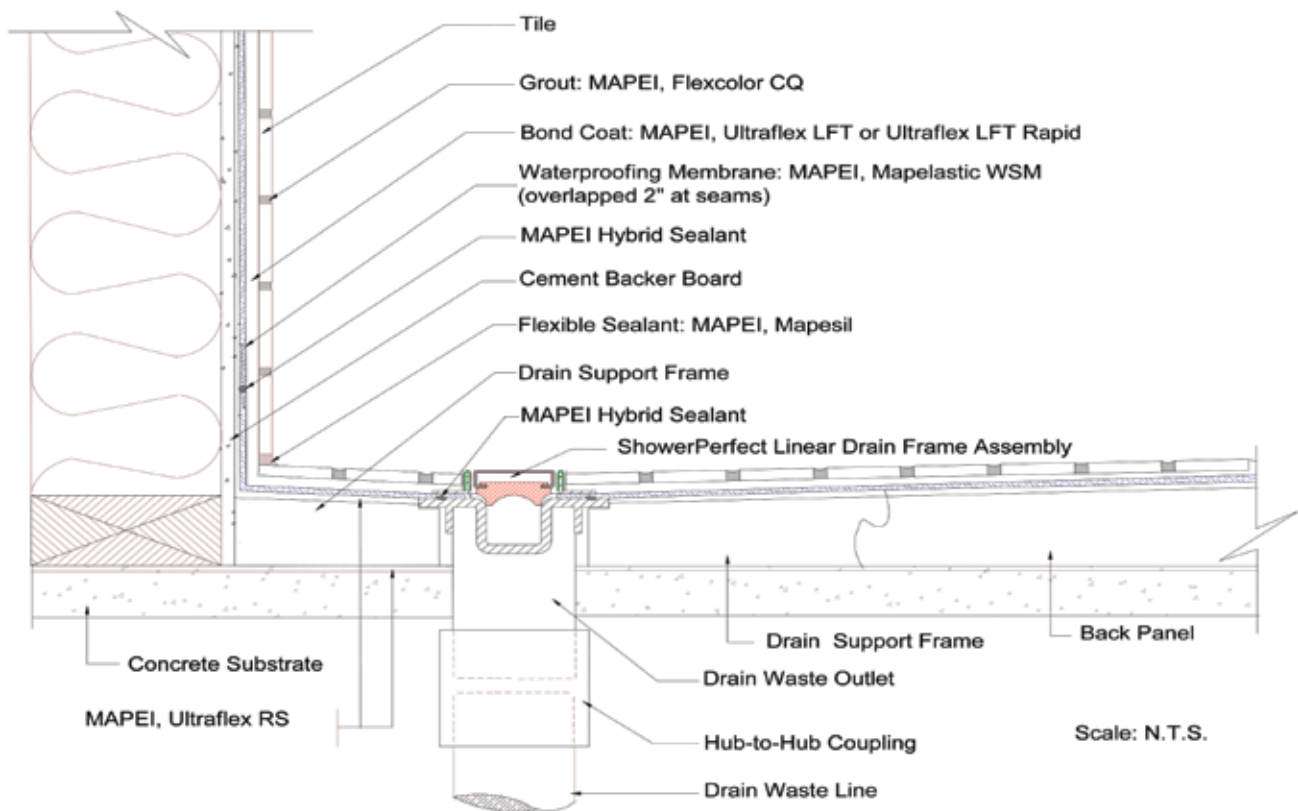

Figure 4: Drain orientation – set 3" to 6" (7,5 to 15 cm) from wall

5. Cut to size and dry-fit all of the components.
 - Start with the drain support frame and align the Linear Drain Body with the waste line "stub-out" in the floor, and then fit in the shower pan and curb components.
 - Because grooves on the drain support frame are at the same elevation, either side can be used.
 - To determine the final measurement before cutting the drain line stub-out, measure from the top of the recessed groove in the drain frame to the top of the stub-out. This final measurement should be 2-3/8" (6 cm) overall (see Figure 5).
 - When installing the no-hub coupling (see Step 9, Option 2), elongate the hole on one side of the substrate to accommodate tightening of the worm gear screw.



Figure 5: Measure from the recessed groove to the top of the "stub-out."

6. Use MAPEI's *Ultraflex RS* rapid-setting thin-set mortar to set the *ShowerPerfect* pre-sloped pan.
 - To achieve the desired mortar bond coat thickness of 3/16" (4,5 mm), use a 1/4" x 3/8" x 1/4" (6 x 10 x 6 mm) square-notched trowel.
 - If thin-set thickness will exceed 3/16" (4,5 mm) anywhere under the pan, level the substrate first and then set the pan using the thin-set. (Consult MAPEI's Technical Services Department for product-leveling recommendations.)
7. Key in and comb the thin-set onto the subfloor using a 1/4" x 3/8" x 1/4" (6 x 10 x 6 mm) square-notched trowel. Starting from the back wall, spread thin-set about 20" (51 cm) parallel to this wall.
 - Set the first *ShowerPerfect* pre-sloped panel into the thin-set as the "back panel."
 - Repeat the process by setting the second *ShowerPerfect* panel into the thin-set as the "front panel."
 - After both panels have been set, set the drain support frame, locking it into both panel pieces using the pre-cut channels.
 - Lastly, set the shower curb into the thin-set. Then, using the lag screws provided in the kit, secure the shower curb to both the *ShowerPerfect* pre-sloped panels and drain support frame. (Ensure that the lag screws are set horizontally, perpendicular to the *ShowerPerfect* pre-sloped panels.)



Figure 6: MAPEI's *Ultraflex RS* being used to set *ShowerPerfect* pre-sloped pan and drain support frame



Figure 7: *ShowerPerfect* pre-sloped pans and drain support frame installed and ready for next step

8. **Option 1*:** Use standard plumbing practices to clean, prime and glue the PVC drain waste outlet to the 2" (5 cm) PVC drain waste line using the hub-to-hub coupling.

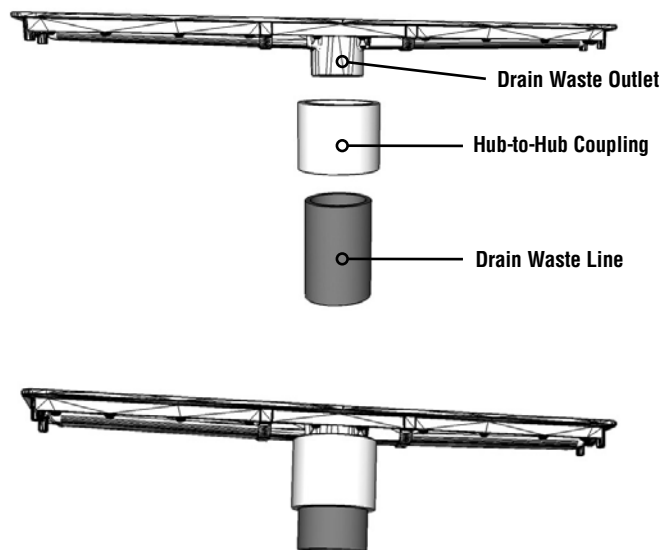

Figure 8: Clean, prime and glue the drain to the 2" (5 cm) waste line (see Figure 4) – exploded view and assembled view

Option 2*: Attach the no-hub coupling to any code-appropriate 2" (5 cm) drain waste line (PVC, copper, cast iron, etc.) and the 2" (5 cm) PVC drain waste outlet. In order to access and tighten both the worm gear screws on the bottom and top:

- First, attach the no-hub coupling to the drain waste line and tighten the bottom worm gear screw.
- Finally, attach the drain waste outlet to the no-hub coupling and tighten the top worm gear screw.

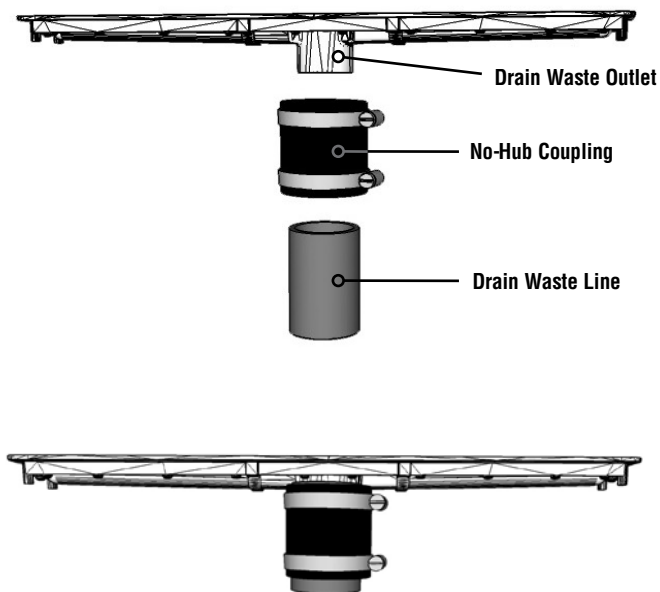

Figure 9: Attach the drain, no-hub coupling and 2" (5 cm) waste line (see Figure 4) – exploded view and assembled view

* *Note: Plumbing components must be purchased separately and are not included in the kit.*

9. With the appropriate screws, secure the Linear Drain Body to the substrate (plywood or concrete) through the holes in the Linear Drain Body. To secure the Linear Drain Body in place, use #8" x 2" (20 x 5 cm) wood screws for plywood and 3/16" x 2-1/4" (4,5 mm x 5,7 cm) Tapcon flat Phillips head fasteners for concrete.

10. Cut the green masking tape along the inside of the metal frame.
 - Make sure that the cut is clean and goes all the way through to allow for a clean separation of the tape.
 - Remove the screws holding the metal frame to the Linear Drain Body and completely remove the whole metal frame.
 - The green masking tape will still be on at this point. Peel off the green masking tape from the outer perimeter of the Linear Drain Body.



Figure 10: Peel off the green masking tape from the outer perimeter of the Linear Drain Body.

11. The *ShowerPerfect* SM Installation Kit contains a 39" x 30' (99 cm x 9,14 m) sheet membrane that will allow you to waterproof a standard-size shower compartment, both floor and walls. Measure and field-cut to the specific size of your shower compartment; remember to leave room for 2" (5 cm) overlaps wherever membrane pieces meet.
12. Now *Ultraflex RS* can be trowel-applied to the floor, including about 4" to 6" (10 to 15 cm) up the wall. Use a 3/16" x 5/32" (4,5 x 4 mm) sawtooth V-notch trowel.
13. Apply a single bead of *ShowerPerfect* Hybrid Sealant 3/16" to 1/4" (4,5 to 6 mm) around the entire perimeter of the Linear Drain Body.



Figure 11: Apply a single bead of *ShowerPerfect* Hybrid Sealant to the perimeter of the Linear Drain Body.

14. Next, set the membrane into the mortar and cove it up the wall. Position the membrane over the Linear Drain Body and feel with your fingers for the "locator pins" (see Figure 11) that will be sticking up from the drain body. Press the fabric down over the locator pins until these protrude through the fabric to create a continuous layer of waterproofing. Using both a grout float and a vinyl floor roller (see Figure 12), remove any creases or bubbles in the membrane to ensure bond between the mortar and sloped mortar bed.



Figure 12: Position *Mapelastic WSM* over locator pins of the Linear Drain Body.



Figure 13: Use a vinyl floor roller to remove any creases or bubbles in *Mapelastic WSM*.

15. Next, reinstall the metal frame to the Linear Drain Body using the screws that you had previously removed.
16. Now, trowel and place the pre-cut wall membrane into the mortar. Make sure to leave a 6" (15 cm) overlap on the floor membrane covered up the wall and a 2" (5 cm) overlap at any wall seams.
17. Finally, with all the sheet membranes set in place, apply *ShowerPerfect* Hybrid Sealant to the back of the pre-formed corners, U-shaped curb cover and under the 2" (5 cm) overlap on the wall coving. Also ensure that all wall seams with a 2" (5 cm) overlap have been treated with the sealant.



Figure 14: Adhere the pre-formed corners, U-shaped curb cover and 2" (5 cm) overlaps using *ShowerPerfect* Hybrid Sealant.

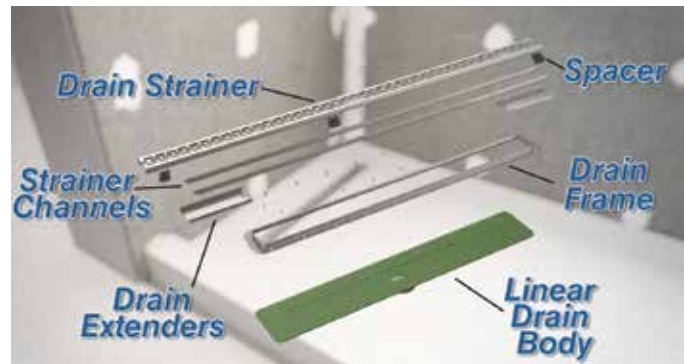

Figure 15: Drain assembly – exploded view

18. Position the holes in the drain frame over the corresponding locator pins; this ensures the correct location of the frame, so that the holes in the frame align with the holes in the Linear Drain Body.
19. Secure the end screws down first on each side; then, secure the rest of them in any order. The torque should be set to 12 ft.-lbs. for all of the frame screws.
20. Cut again along the inside of the drain frame through the reinforcement fabric. Repeat the cut if necessary to make sure that the fabric is completely cut through for easy removal.
 - Note: Do not remove the cut fabric or leftover green masking tape from around the perimeter until the tile installation is complete. This will protect the drain from any foreign debris.
21. To enhance the benefits of the linear drain, extenders are included in the kit to accommodate a wall-to-wall shower installation:
 - **Step 1:** Measure and mark the trough extensions to fit the installation.
 - **Step 2:** Measure from the end screws to the wall or curb and deduct 3/8" (10 mm) – or as much as needed – to accommodate for the thickness of the wall tile and thin-set combined.
 - **Step 3:** Cut the trough extensions as marked.
 - **Step 4:** Loosen the two end screws on each end enough to be able to slide the trough extensions under the screw heads.

- **Step 5:** Measure and cut the strainer channels as needed on both sides to fit the drain frame and extensions.
- **Step 6:** Slide each strainer channel over the vertical portion of the drain frame and vertical parts of the trough extensions.
- **Step 7:** Retighten both screws to 12 ft.-lbs. of torque.
- **Step 8:** Install ceramic, stone or glass tile over the *ShowerPerfect* pan and walls.
- **Step 9:** After tile installation, cut the tile-in drain strainer to size in order to accommodate the notches on the frame.

Note: The tile-in drain strainer kit includes pre-cut tape, which performs as waterproofing, to adhere to the inside of the strainer channel. The tile is then set with mortar over the tape in the channel.

- **Step 10:** Slide spacers into the drain cover and place in the trough. Spacers provide 1/8" (3 mm) of incremental adjustment.
22. If state, federal, local or provincial codes require flood testing, perform testing per ASTM D5957 and IAPMO guidelines before commencing with tilework.

APPLICABLE INDUSTRY CODES, STANDARDS AND GUIDELINES

Note 1

– International Plumbing Code (IPC) 2012

SECTION 417 Showers

417.4 Shower compartments

Shower compartments shall be not less than 900 square inches (0.58 m²) in interior cross-sectional area. Shower compartments shall be not less than 30 inches (762 mm) in least dimension as measured from the finished interior dimension of the compartment, exclusive of fixture valves, showerheads, soap dishes, and safety grab bars or rails. Except as required in Section 404, the minimum required area and dimension shall be measured from the finished interior dimension at a height equal to the top of the threshold and at a point tangent to its centerline and shall be continued to a height not less than 70 inches (1778 mm) above the shower drain outlet.

Exception: Shower compartments having not less than 25 inches (635 mm) in minimum dimension measured from the finished interior dimension of the compartment, provided that the shower compartment has not less than of 1,300 square inches (.838 m²) of cross-sectional area.

Note 2

– International Residential Code (IRC) 2012

SECTION P2709 Shower Receptors

P2709.1 Construction

Where a shower receptor has a finished curb threshold, it shall be not less than 1 inch (25 mm) below the sides and back of the receptor. The curb shall be not less than 2 inches (51 mm) and not more than 9 inches (229 mm) deep when measured from the top of the curb to the top of the drain. The finished floor shall slope uniformly toward the drain not less than 1/4 unit vertical in 12 units horizontal (2-percent slope) nor more than 1/2 unit vertical per 12 units horizontal (4-percent slope) and floor drains shall be flanged to provide a water-tight joint in the floor.

P2709.2 Lining required

The adjoining walls and floor framing enclosing on-site built-up shower receptors shall be lined with one of the following materials:

1. Sheet lead;
2. Sheet copper;
3. Plastic liner material that complies with ASTM D4068 or ASTM D4551;
4. Hot mopping in accordance with Section P2709.2.3; or
5. Sheet-applied load-bearing, bonded waterproof membranes that comply with ANSI A118.10. The lining material shall extend not less than 2 inches (51 mm) beyond or around the rough jambs and not less than 2 inches (51 mm) above finished thresholds. Sheet-applied load-bearing, bonded waterproof membranes shall be applied in accordance with the manufacturer's instructions.

P2709.2.4 Liquid-type, trowel-applied, load-bearing, bonded waterproof materials
Liquid-type, trowel applied, load-bearing, bonded waterproof materials shall meet the requirements of ANSI A118.10 and shall be applied in accordance with the manufacturer's instructions.

P2709.4 Receptor drains

An approved flanged drain shall be installed with shower sub pans or linings. The flange shall be placed flush with the subbase and be equipped with a clamping ring or other device to make a water-tight connection between the lining and the drain. The flange shall have weep holes into the drain.

Note 3

– International Residential Code (IRC) 2012

SECTION R702

R702.4.2 Fiber-cement, fiber-mat reinforced cement backer units, glass mat gypsum backers and fiber-reinforced gypsum backers

Fiber-cement, fiber-mat reinforced cementitious backer units, glass mat gypsum backers or fiber-reinforced gypsum backers in compliance with ASTM C1288, C1325, C1178 or C1278, respectively, and installed in accordance with manufacturers' recommendations shall be used as backers for wall tile in tub and shower areas and wall panels in shower areas.

Note 4

Mapelastix WSM

- Exceeds ANSI A118.10 for waterproofing
- IAPMO-listed
- Exceeds ANSI A118.12 for crack isolation

Ultraflex RS

- Meets or exceeds ANSI A118.4F and A118.15F
- Classified as ISO 13007 C2FS1P1

Note 5

When setting thin-body (3 to 6 mm) large-format tile in a shower, refer to both the thin-tile manufacturer and the MAPEI Reference Guides noted below before beginning the installation on walls and floors.

1. "Thin-Body Porcelain Tile Reference Guide for Interior Floors – 4,5 to 6 mm in Thickness" (RGT0112)
2. "Thin-Body Porcelain Tile Reference Guide for Interior and Exterior Walls, Ceilings and Soffits – 3 to 6 mm in Tile Thickness" (RGT0113)

Note 6

Use any appropriate MAPEI mortar, grout and sealant for the installation of glass tile, ceramic tile, porcelain tile or stone in shower stalls. Consult MAPEI's most current TDSs and Safety Data Sheets at www.mapei.com.

Follow all applicable industry standards, codes and guidelines:

- American National Standards Institute (ANSI)
- International Organization for Standardization (ISO)
- TCNA
- Terrazzo, Tile and Marble Association of Canada (TTMAC)
- Marble Institute of America (MIA)
- International Construction Codes (ICC)
- International Building Codes (IBC)
- IRC
- IPC
- American Standards and Test Methods (ASTM International)

MEMBRANE SEAMS AND CORNERS

Note 7

ShowerPerfect Hybrid Sealant – Use to adhere all pre-formed corners, U-shaped curb covers and seams to *Mapelastix WSM*.









MOVEMENT JOINTS



Note 8

Field movement joints are required within tile installations. Expansion, construction and contraction joints should be carried through the tile without exception. Refer to the most current TCNA Handbook, Detail EJ171; or the TTMAC Tile Installation Manual, Detail 301MJ.

MAPEI's *Mapesil*™ 100%-silicone sealant

- Meets ASTM C920; Type S; Grade NS; Class 25; Use NT, M, G, A and O
- Meets the requirements of TCNA Handbook Detail EJ171
- Conforms to ASTM C794 Adhesion Properties
- Interior/exterior residential and commercial installations from Res1 to Res6 and Com1 to Com6 per TCNA Environmental Classifications

Components included in the <i>ShowerPerfect</i> SM Installation Kit	
	<i>ShowerPerfect</i> Pre-Sloped Panels 16" x 52" (41 x 132 cm)
	<i>ShowerPerfect</i> Drain Support Frame 32" x 12" (81 x 30 cm)
	<i>ShowerPerfect</i> Curb
	<i>Mapelastic WSM</i> 39" x 30' (99 cm x 9,14 m)
	<i>ShowerPerfect</i> Shower Curb Lag Screws
	<i>ShowerPerfect</i> SM Inside Corners
	<i>ShowerPerfect</i> SM U-Shaped Curb Cover
	<i>ShowerPerfect</i> Hybrid Sealant

Preferred additional MAPEI products for shower tile installation	
	<i>Ultraflex</i> ™ LFT™ or <i>Ultraflex LFT Rapid</i> mortar bond coat
	<i>MAPEI Flexcolor</i> ™ CQ grout
	<i>Mapesil</i> 100%-silicone sealant

Additional <i>ShowerPerfect</i> components to order/purchase separately	
	<i>ShowerPerfect</i> Drain Strainer <ul style="list-style-type: none"> • Brushed stainless steel • Polished stainless steel • Oil-rubbed bronze • Tile-in drain
	<i>ShowerPerfect</i> Linear Drain Assembly Kit
	<i>ShowerPerfect</i> Drain Extenders
	<i>ShowerPerfect</i> Drain Body Floor Supports
	<i>ShowerPerfect</i> Strainer Channels
	<i>ShowerPerfect</i> Stainless Steel Base Screws
	<i>ShowerPerfect</i> Strainer Tools
	<i>ShowerPerfect</i> Strainer Spacers
	<i>Ultraflex RS</i> pan mortar

Required items not sold by MAPEI	
Product description	
Drain assembly	8" x 2" (20 x 5 cm) wood screws for plywood substrate
Drain assembly	3/16" x 2-1/4" (4,5 x 5,7 cm) Tapcon flat Phillips head fastener for concrete substrate
No-hub coupling	
Hub-to-hub coupling	



MKT: 14-0294 PR: 7015
© 2014 MAPEI Corporation.
All Rights Reserved. Printed in the USA.

MAPEI Headquarters of the Americas
1144 East Newport Center Drive
Deerfield Beach, Florida 33442
Phone: 1-888-US-MAPEI
(1-888-876-2734)

Technical Services
1-800-992-6273 (U.S. and Puerto Rico)
1-800-361-9309 (Canada)

Customer Service
1-800-42-MAPEI (1-800-426-2734)

Services in Mexico
0-1-800-MX-MAPEI (0-1-800-696-2734)

Document Number: IGT0414
Edition Date: July 1, 2014